

Cell Structure and Plasma Membrane Function Practice Questions

Name: _____

Date: _____

1. Use this diagram to answer the question.

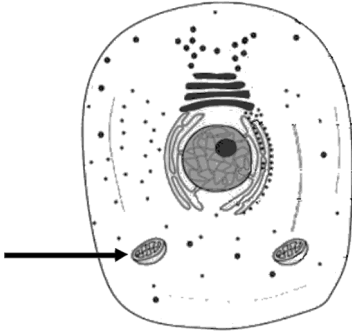

What is the main purpose of the mitochondria shown by the arrow?

- A. cell reproduction
- B. cellular digestion
- C. energy production
- D. protein manufacture

2. Which statement about plant and animal cells is true?

- A. Both have a cell wall to give them support.
- B. Both have a large vacuole to store water.
- C. Both use mitochondria to produce energy.
- D. Both use chloroplasts to store energy.

3. A potato core was placed in a beaker of water as shown in the figure below.

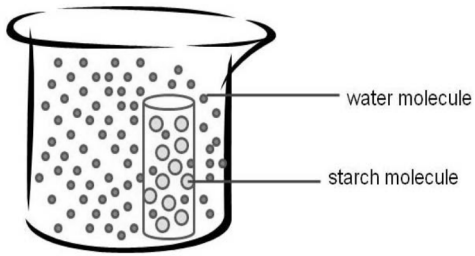

Which diagram *best* represents the net movement of molecules?

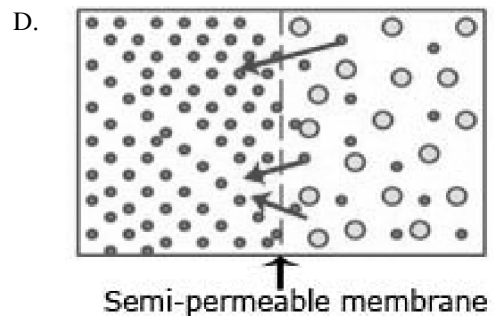
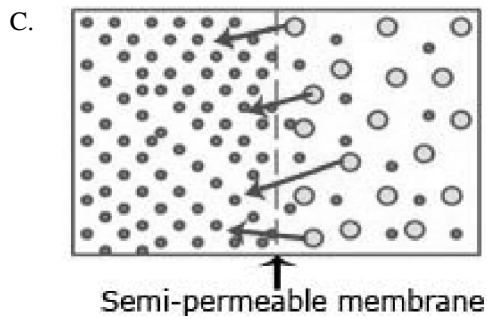
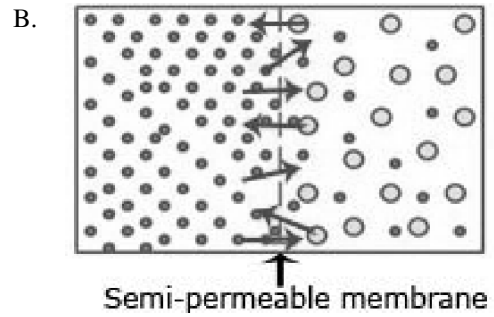
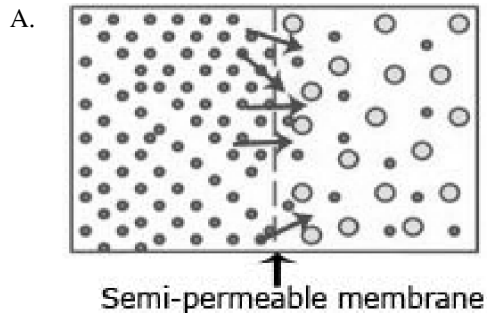

4. The cell membrane of the red blood cell will allow water, oxygen, carbon dioxide, and glucose to pass through. Because other substances are blocked from entering, this membrane is called

- A. perforated.
- B. semi-permeable.
- C. non-conductive.
- D. permeable.

5. The plasma membrane of a cell consists of

- A. protein molecules arranged in two layers with polar areas forming the outside of the membrane.
- B. two layers of lipids organized with the nonpolar tails forming the interior of the membrane.
- C. lipid molecules positioned between two carbohydrate layers.
- D. protein molecules with polar and nonpolar tails.

6.

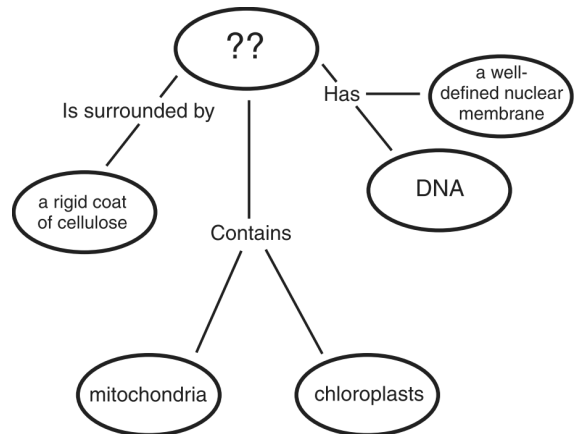

Which of these *best* completes this concept map?

- A. an animal cell
- B. a prokaryotic cell
- C. a virus
- D. a plant cell

7. Eukaryotic cells are differentiated from prokaryotic cells because eukaryotic cells
- A. are much smaller.
 - B. have permeable membranes.
 - C. have a higher rate of reproduction.
 - D. have nuclei.

8. A cell from heart muscle would *probably* have an unusually high proportion of
- A. lysosomes.
 - B. mitochondria.
 - C. mRNA.
 - D. Golgi bodies.

9. Depending on its electric charge, shape, and chemical properties, a substance may or may not be allowed to pass through a cell membrane. This function of the cell membrane is important because it _____.
- A. prevents cell division
 - B. prevents destruction of the cell wall
 - C. allows the cell to maintain homeostasis
 - D. allows amino acids to move into and out of the cell

10.

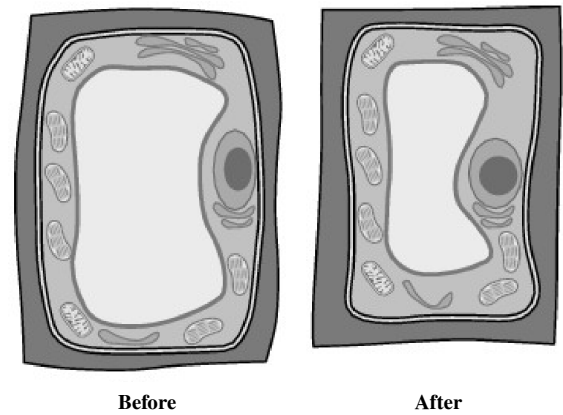

The diagram shows a plant cell before and after it is placed in a solution. After the cell is placed in the solution, it changes shape.

Which table shows the initial concentration of solute in the cell and in the solution that would cause the cell to change shape as shown in the diagram?

A.

Location	Solute Concentration
Inside cell	12%
Outside cell	12%

B.

Location	Solute Concentration
Inside cell	3%
Outside cell	6%

C.

Location	Solute Concentration
Inside cell	7%
Outside cell	5%

D.

Location	Solute Concentration
Inside cell	0%
Outside cell	0%

11. Use the diagrams below of an animal cell and a plant cell to answer the following question.

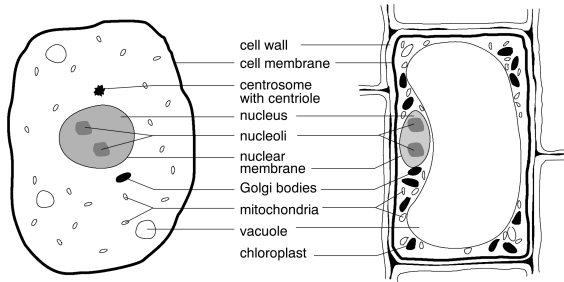

Features of plant cells that clearly make them different from animal cells are

- A. a larger nucleus and fewer chromosomes.
 B. a rigid cell wall and chloroplasts.
 C. more cytoplasm and smaller vacuoles.
 D. a changing size and indefinite shape.
12. The starch and water molecules in potato cells are stored in what organelle?
- A. mitochondrion B. nucleus
 C. ribosome D. vacuole
13. What are the basic structural units of living organisms?
- A. cells B. nuclei
 C. organs D. tissues

14. Which of the following best describes the purpose of the chromosomes in the nucleus of a cell?

- A. to store the genetic instructions needed to specify traits
 B. to release energy by breaking down food molecules
 C. to transport nutrients into and out of the cell
 D. to protect the cell from microorganisms
15. A single prokaryotic cell can divide several times in an hour. Few eukaryotic cells can divide as quickly. Which of the following statements *best* explains this difference?
- A. Eukaryotic cells are smaller than prokaryotic cells.
 B. Eukaryotic cells have less DNA than prokaryotic cells.
 C. Eukaryotic cells have more cell walls than prokaryotic cells.
 D. Eukaryotic cells are more structurally complex than prokaryotic cells.

16. The diagram below illustrates how plant root cells take in mineral ions from the surrounding soil.

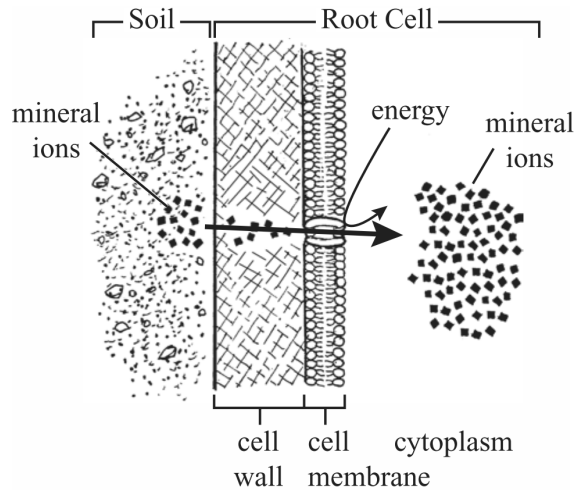

Which of the following processes is illustrated?

- A. active transport B. diffusion
C. osmosis D. passive filtration

17. Which of the diagrams below *best* represents the net movement of molecules in osmosis?

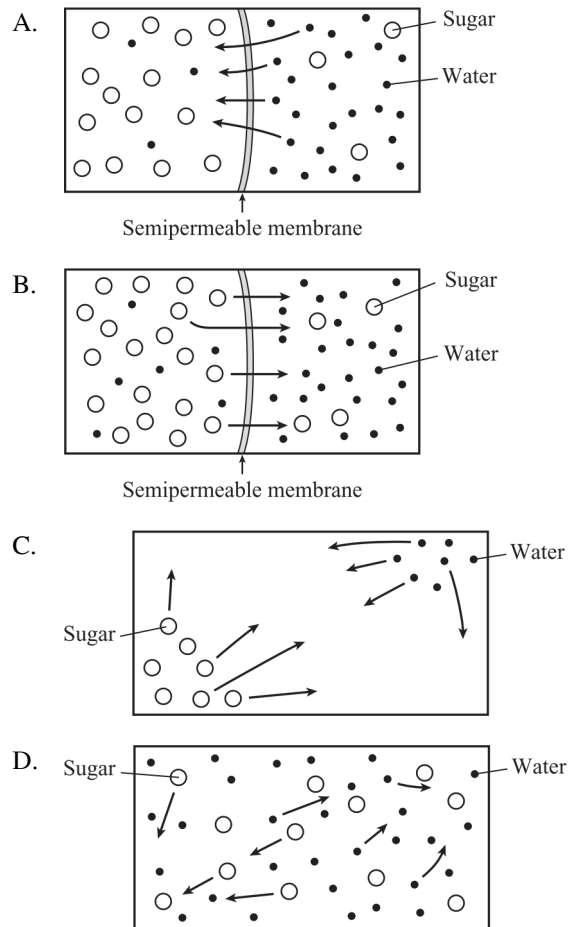

18. Which of the following functions does active transport perform in a cell?
- A. packaging proteins for export from the cell
B. distributing enzymes throughout the cytoplasm
C. moving substances against a concentration gradient
D. equalizing the concentration of water inside and outside the cell

19. Which of the following statements correctly matches a cell part with its function?
- A. The cell membrane packages lipids for export.
 - B. The mitochondria perform photosynthesis.
 - C. The lysosome digests molecules.
 - D. The nucleus produces energy

20. The illustrations below represent two different cells.

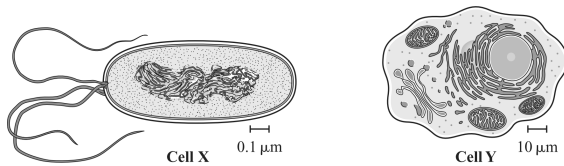

Which of the following statements *best* identifies these two cells?

- A. Cell X is a prokaryotic cell and cell Y is a eukaryotic cell.
- B. Cell X is an archae cell and cell Y is a eubacterial cell.
- C. Cell X is a red blood cell and cell Y is a muscle cell.
- D. Cell X is a plant cell and cell Y is an animal cell.

21. The table below lists the concentrations of water inside and outside a cell under four different conditions.

Condition	Water Concentration in Cell	Water Concentration in Environment
1	90%	95%
2	90%	100%
3	95%	90%
4	95%	95%

Under which condition will the cell experience a net loss of water to its environment?

- A. Condition 1
- B. Condition 2
- C. Condition 3
- D. Condition 4

22. A diagram of a plant cell is shown below.

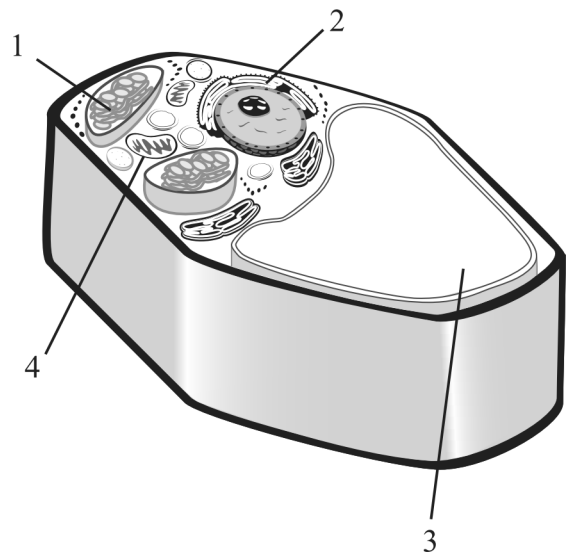

Which number identifies the organelle that functions to store water and dissolved salts?

- A. 1
- B. 2
- C. 3
- D. 4

23. Amino acids, sugars, and ions move across the cell membrane. Their movement from a region of high concentration to a region of low concentration is accomplished by special proteins in the membrane.

Which of the following terms applies to this type of cell transport?

- A. active transport B. facilitated diffusion
C. osmosis D. transcription

24. Which of the following matches a cell organelle with its function?

- A. chloroplast—movement
B. nucleus—cell regulation
C. vacuole—energy production
D. mitochondrion—photosynthesis

25. The diagram below shows a cell with four of its parts numbered.

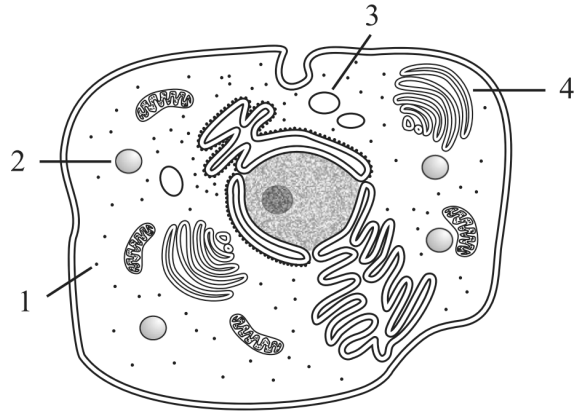

Which numbered part is a ribosome?

- A. 1 B. 2 C. 3 D. 4

26. Use the figure of a cell membrane below to answer the following question(s).

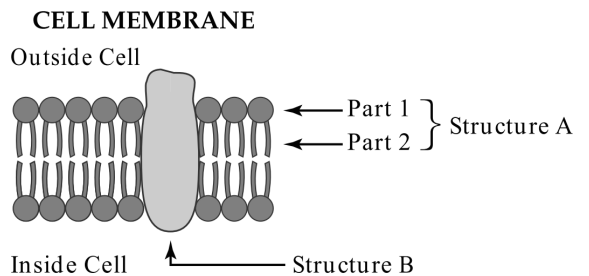

What kind of molecule is Structure A?

- A. an amino acid B. a phospholipid
C. a carbohydrate D. a nucleic acid

27. A scientist wants to study photosynthesis in a newly discovered species. Which of these cell structures should the scientist study?

- A. vacuoles
- B. chloroplasts
- C. mitochondria
- D. ribosomes

28. Which of these is the process by which water moves across a selectively permeable membrane?

- A. osmosis
- B. transpiration
- C. capillary action
- D. active transport

29. Use the information and the diagrams below to answer the following question(s).

A student observed different types of cells under a microscope. Four of the cells he observed are shown below.

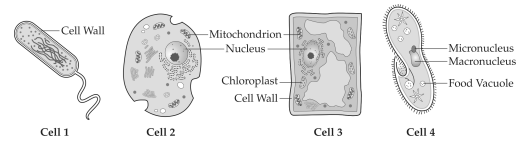

Cell 4 has many hair-like structures that it uses for movement. What are these structures called?

- A. cilia
- B. flagella
- C. vacuoles
- D. pseudopodia

30. Which of these substances moves across cell membranes by osmosis?

- A. salt
- B. sugar
- C. water
- D. protein

Cell Structure and Plasma Membrane Function Practice Questions

05/18/2015

- | | | | |
|---------|---|---------|---|
| 1. | | 21. | |
| Answer: | C | Answer: | C |
| 2. | | 22. | |
| Answer: | C | Answer: | C |
| 3. | | 23. | |
| Answer: | A | Answer: | B |
| 4. | | 24. | |
| Answer: | B | Answer: | B |
| 5. | | 25. | |
| Answer: | B | Answer: | A |
| 6. | | 26. | |
| Answer: | D | Answer: | B |
| 7. | | 27. | |
| Answer: | D | Answer: | B |
| 8. | | 28. | |
| Answer: | B | Answer: | A |
| 9. | | 29. | |
| Answer: | C | Answer: | A |
| 10. | | 30. | |
| Answer: | B | Answer: | C |
| 11. | | | |
| Answer: | B | | |
| 12. | | | |
| Answer: | D | | |
| 13. | | | |
| Answer: | A | | |
| 14. | | | |
| Answer: | A | | |
| 15. | | | |
| Answer: | D | | |
| 16. | | | |
| Answer: | A | | |
| 17. | | | |
| Answer: | A | | |
| 18. | | | |
| Answer: | C | | |
| 19. | | | |
| Answer: | C | | |
| 20. | | | |
| Answer: | A | | |